



# 目 录

一、运输作业组织与管理模块..... 2

二、仓储与配送作业组织与管理模块..... 34

三、国际物流作业组织与管理模块..... 150

四、 快递物流作业组织与管理模块.....	213
-----------------------	-----

湖南商务职业技术学院物流管理专业学生技能考核题库

## 一、运输作业组织与管理模块

○

○

○

--	--	--

○

○

--	--	--	--	--

## ( ) 任务描述

- :
- 
-





<input type="checkbox"/> <input type="checkbox"/>				<input type="checkbox"/> <input type="checkbox"/>				
<input type="checkbox"/> <input type="checkbox"/>								
						<input type="checkbox"/> <input type="checkbox"/> <input type="checkbox"/> <input type="checkbox"/>		





( ) 任务描述:

- 
- 
- 









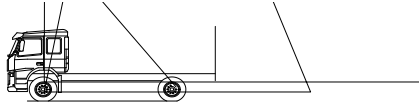



( ) 任务描述:



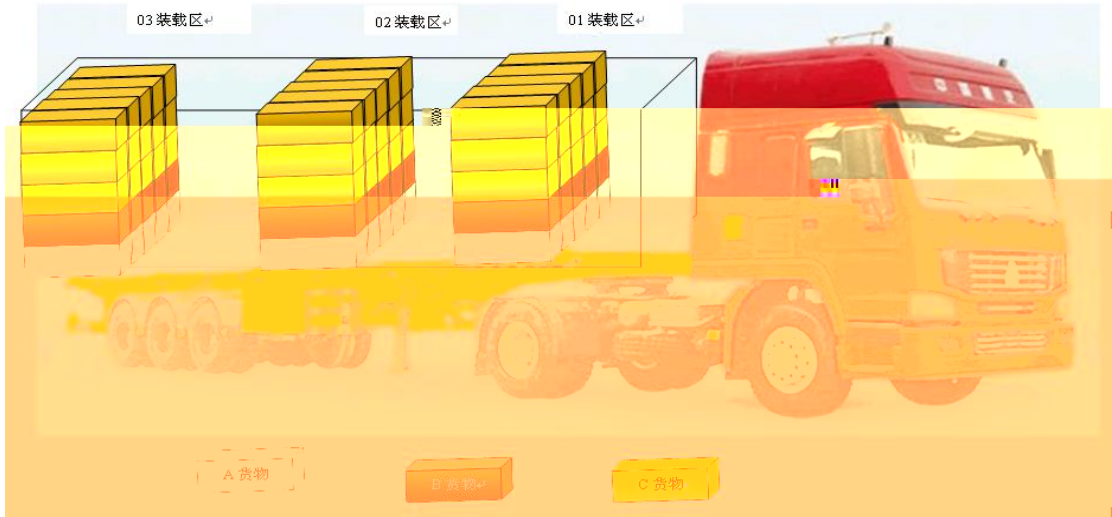

○

○

○

○

○



( ) 任务描述



**D**

<input type="checkbox"/>		<input type="checkbox"/>				<input type="checkbox"/>	<input type="checkbox"/>		
<input type="checkbox"/>		<input type="checkbox"/>							
						<input type="checkbox"/>	<input type="checkbox"/>	<input type="checkbox"/>	<input type="checkbox"/>





**2**



**3**

**4**



( ) 任务描述

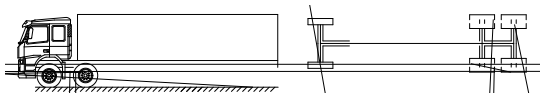
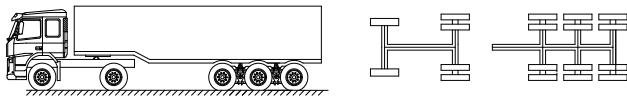
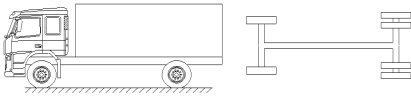







( ) 任务描述

- 
- 
- 
- 
- 





**( ) 任务描述**

HF

1

GUANGZHOU HF Trading CO., LTD.  
Room 502, No.838, Dongfeng Road, Guangzhou, China  
TEL: 020-87656751 FAX: 020-87656772

2

AL QADAH TRADING COMPANY L.L.C  
202 W. 1st St. LOS ANGELES, CA 90012  
Phone (877) 554-4000 Fax (213) 237-3535

3

PRODUCT: CLEANING BALL  
PARTIAL SHIPMENT                    allowed  
TRANSSHIPMENT                    : allowed

		CARTONS)	(CBM)			

4 TIME OF SHIPMENT (                    ) 2016 5 15

5 SERVICE TYPE (                    ) CY/CY

6 FREIGHT (                    ) PREPAID

7 PORT OF LOADING (                    ) SHENZHEN

8 PORT OF DISCHARGE (                    ) LOS ANGELES

9

USD1450/20GP, USD1800/40GP, USD1800/40HQ



*SHIPPER : (            )	/			
	*			
	*	*		
	*			
*CONSIGNEE	* /			
	*			
NOTIFY PARTY:			-	
* /	*	*	*	*

MARK NUMBERS										DESCRIPTION OF GOODS										KGS		KGS		CBM	
√																									
*										√															
										CY/CY √ CFS/CY															
										CFS/CFS															



Sailing Schedule from : Shenzhen,Shenzhen,Guangdong,China

To : Los Angeles,Los Angeles,CA,United States

Origin City : Shenzhen,Shenzhen,Guangdong,China

CY/DOOR

Destination City : Los Angeles,Los Angeles,CA,United States

CY/DOOR

序列号	航线	船名	航次	截关时间	装货港	预计离港时间	实际离港时间	卸货港
1	YPSW	YM UNISON	59E	2016-04-22 17:00	Yantian	2016-04-25		Los Angeles
2	SEA	NORTHERN JAVELIN	002E	2016-04-23 12:00	Yantian	2016-04-27		Long Beach
3	AAS2	CMA CGM LIBRA	095TXE	2016-04-25 16:00	Yantian	2016-04-28		Long Beach
4	YPSW	YM UBIQUITY	22E	2016-04-29 17:00	Yantian	2016-05-02		Los Angeles
5	SEA	C SCL PUSAN	117E	2016-04-30 12:00	Yantian	2016-05-04		Long Beach
6	AAS2	CMA CGM COLUMBA	097TXE	2016-05-02 16:00	Yantian	2016-05-05		Long Beach
7	SEA	COSCO NINGBO	069W	2016-05-06 11:00	Yantian	2016-05-08		Long Beach
8	YPSW	YM JIREBY...	50E	2016-05-06 17:00	Yantian	2016-05-09		Los Angeles
9	SEA	COSCO EXCELLENCE	027E	2016-05-07 12:00	Yantian	2016-05-11		Long Beach
10	AAS2	CMA CGM CENTAURUS	099TXE	2016-05-09 16:00	Yantian	2016-05-12		Long Beach
11	YPSW	YM MASCULINITY	32E	2016-05-13 17:00	Yantian	2016-05-16		Los Angeles
12	SEA	HONG KONG BRIDGE	039E	2016-05-14 12:00	Yantian	2016-05-18		Long Beach
13	AAS2	CMA CGM THALASSA	101TXE	2016-05-16 16:00	Yantian	2016-05-19		Long Beach



干货箱



	箱体内部尺寸			箱体内容积及载重量		箱门开度尺寸	
	L	W	H	Cu	P	W	H
20'	5898	2352	2393	33.2	21740/28230#	2340	2280
40'	12032	2352	2393	67.7	26630	2340	2280
HC	12032	2352	2698	76.3	26520	2340	2585

冷藏箱



	箱体内部尺寸			箱体内容积及载重量	
	L	W	H	Cu	P
20'	5444	2284	2267	28.5	21135/27160#
40'	11583	2284	2250	58.7	26580

开顶箱

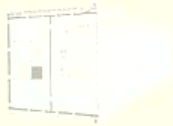

	箱体内部尺寸			箱体内容积及载重量	
	L	W	H	Cu	P
20'	5898	2352	2393	33.2	21740
40'	12032	2352	2393	67.7	26630

○

○

( ) 实施条件

( ) 考核时量

( ) 评分细则

1

		10			
				5	



				10	
				5	
					5
					10

( ) 任务描述





□		□		
□		□		

○

○



”

○

○

( ) 实施条件

( ) 考核时量

( ) 评分细则

		1			
				10 5	
				5	
		10			

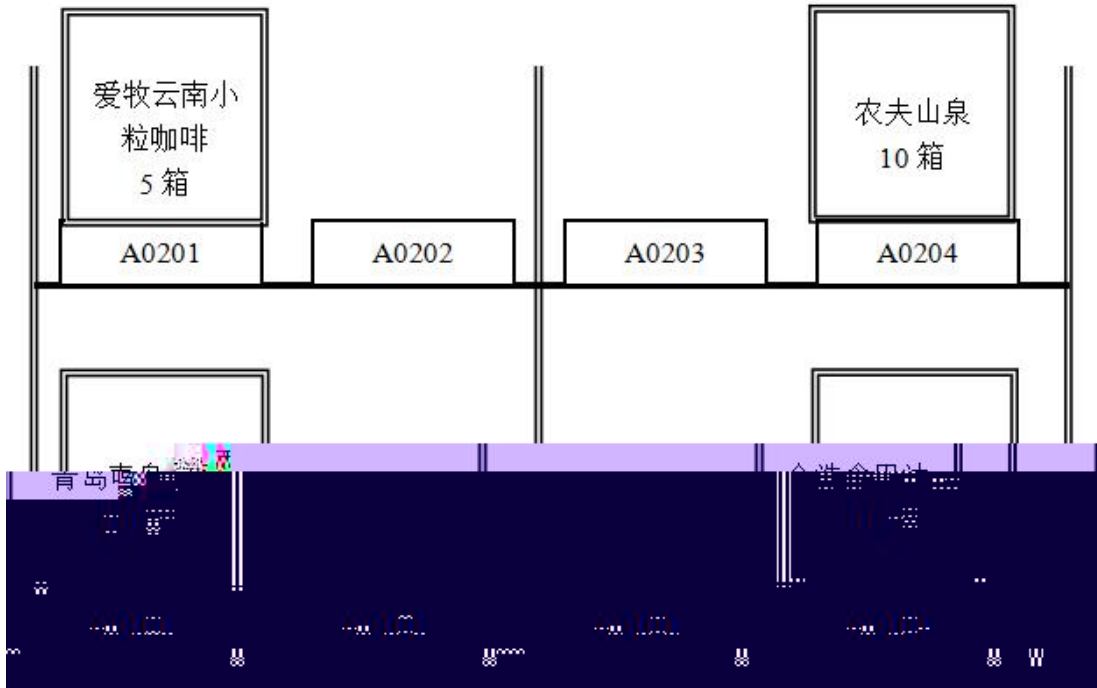

# 产品运输单

---



- 
- 
- 
- 
- 
- 
- 
- 







80				





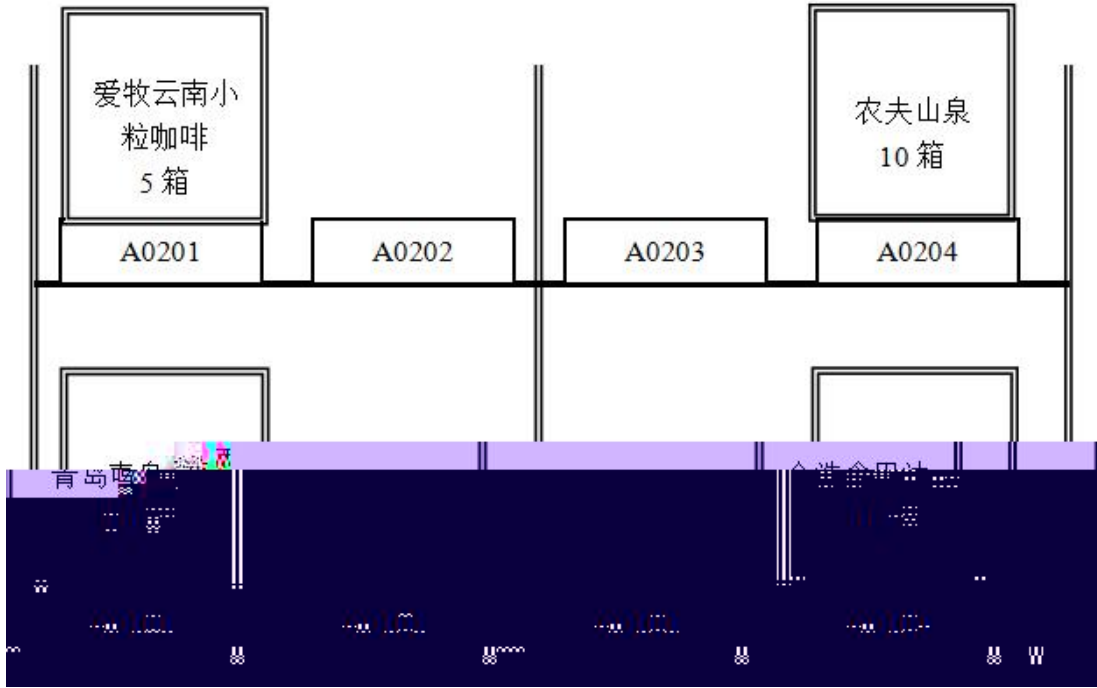



# 产品运输单

---



- 
- 
- 
- 
- 
- 
- 
-











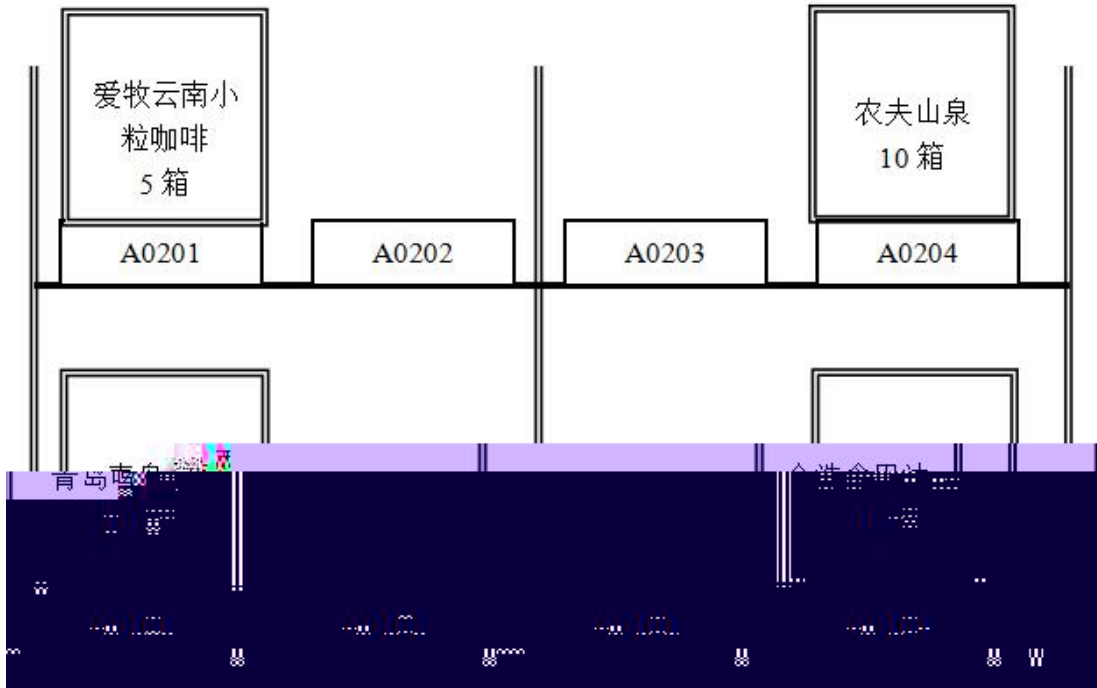

# 产品运输单

---



- 
- 
- 
- 
- 
- 
- 
-











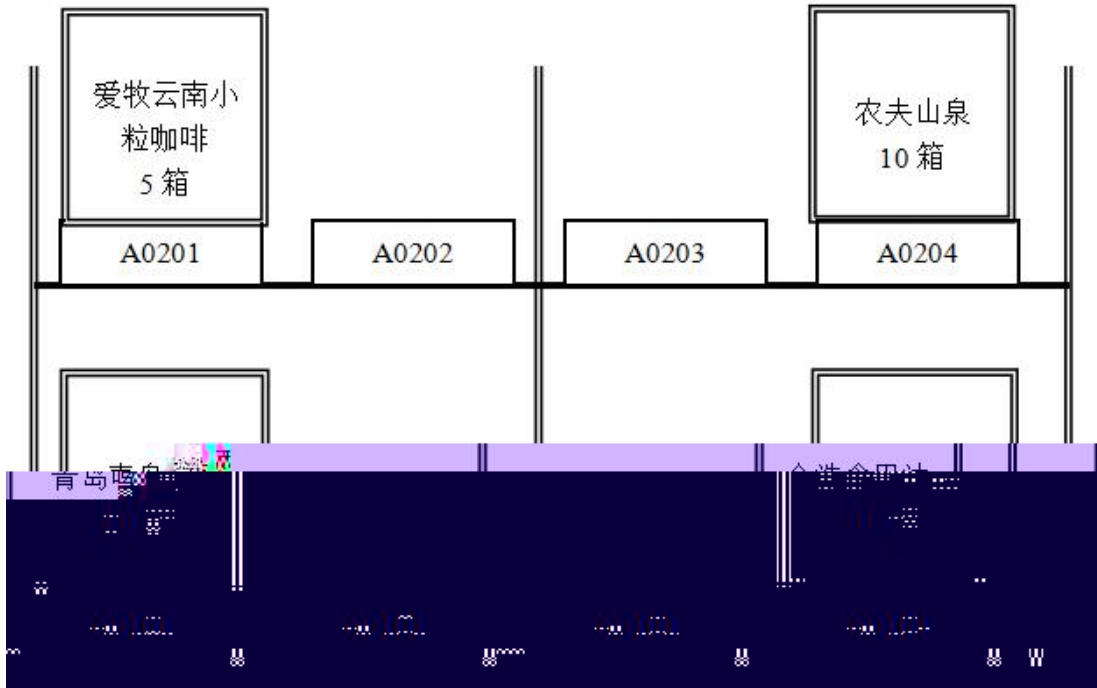

# 产品运输单

---



- 
- 
- 
- 
- 
- 
- 
-





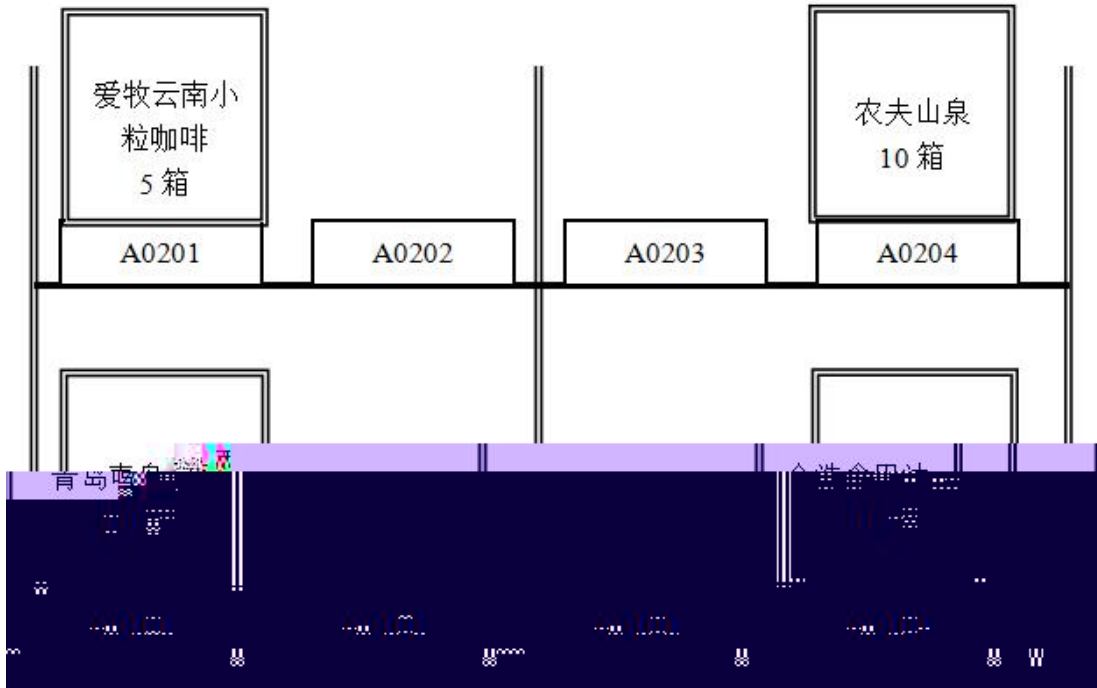

# 产品运输单

---



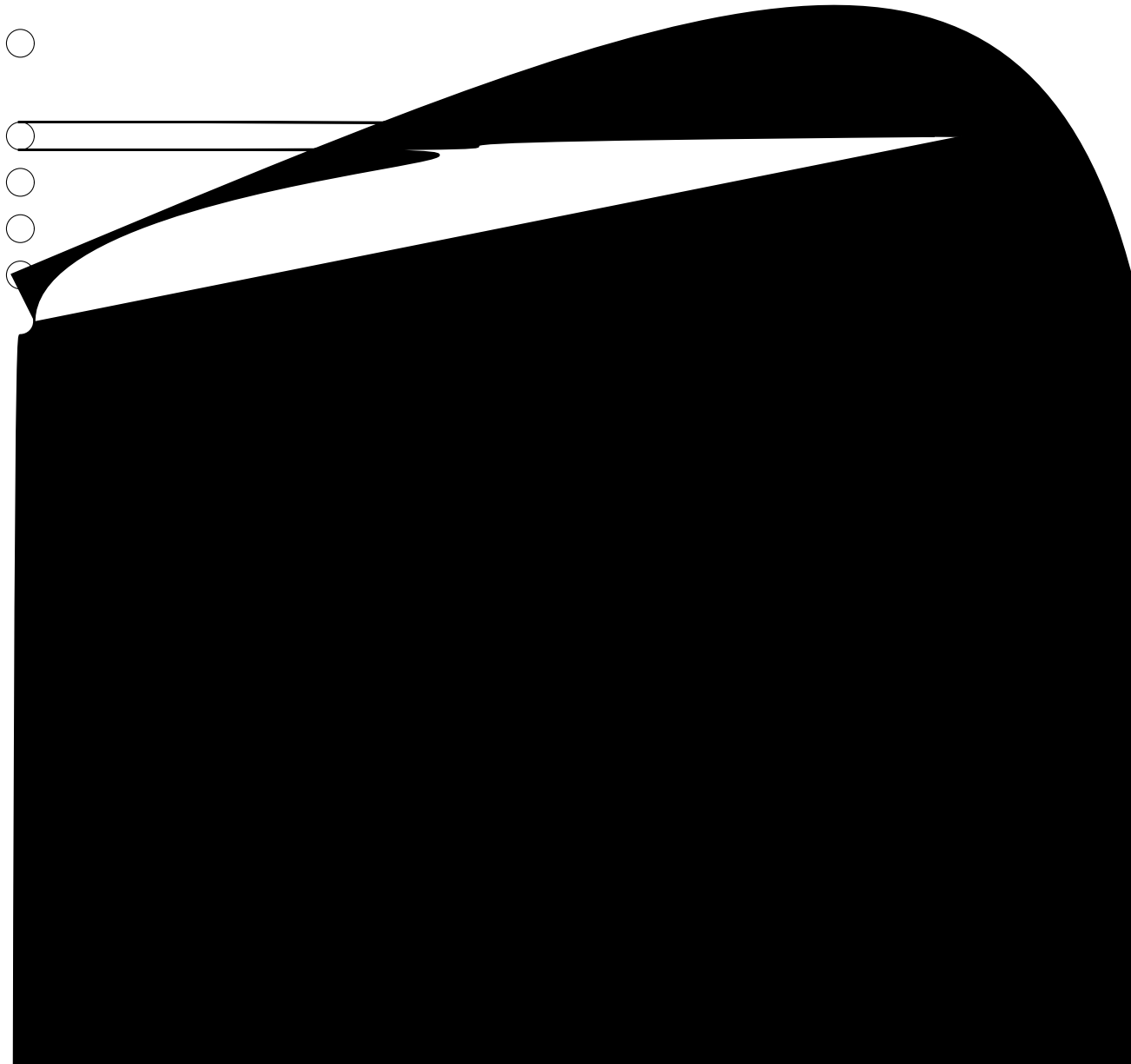





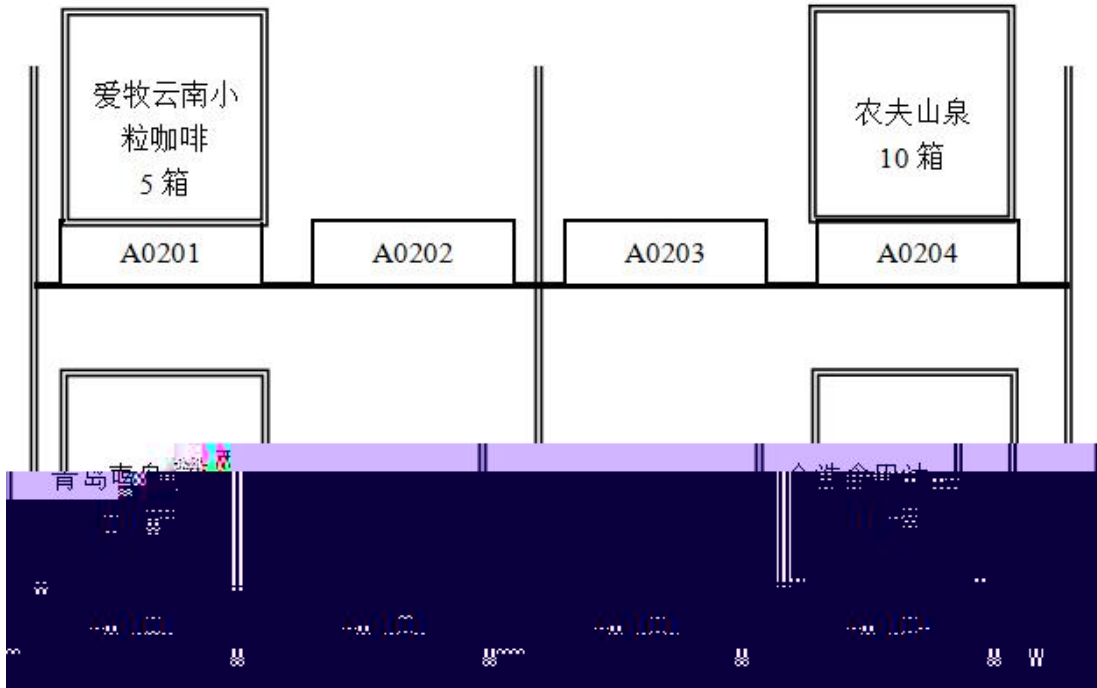

## 产品运输单











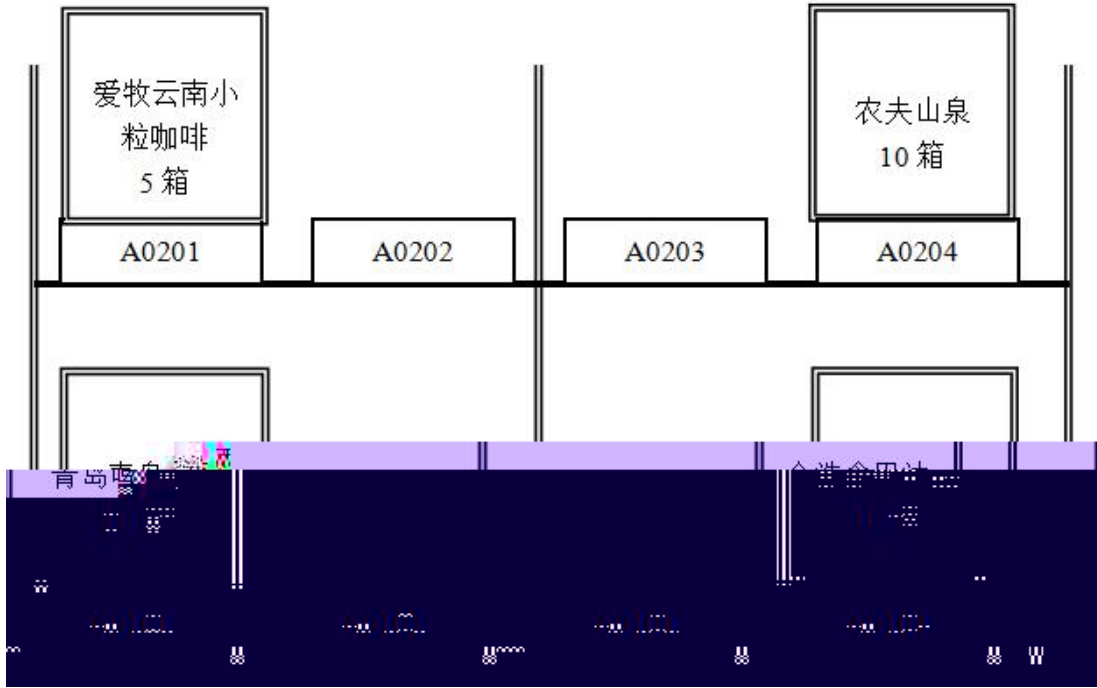

# 产品运输单

---



- 
- 
- 
- 
- 
- 
- 
- 
- 









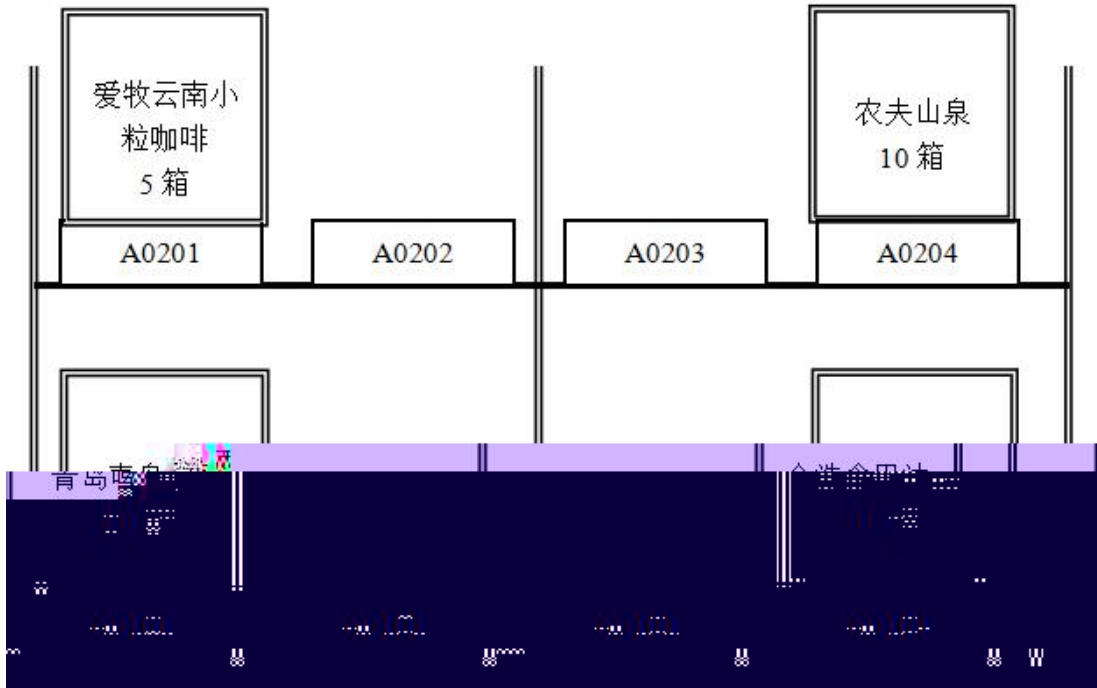

# 产品运输单

---



- 
- 
- 
- 
- 
- 
- 
- 
-









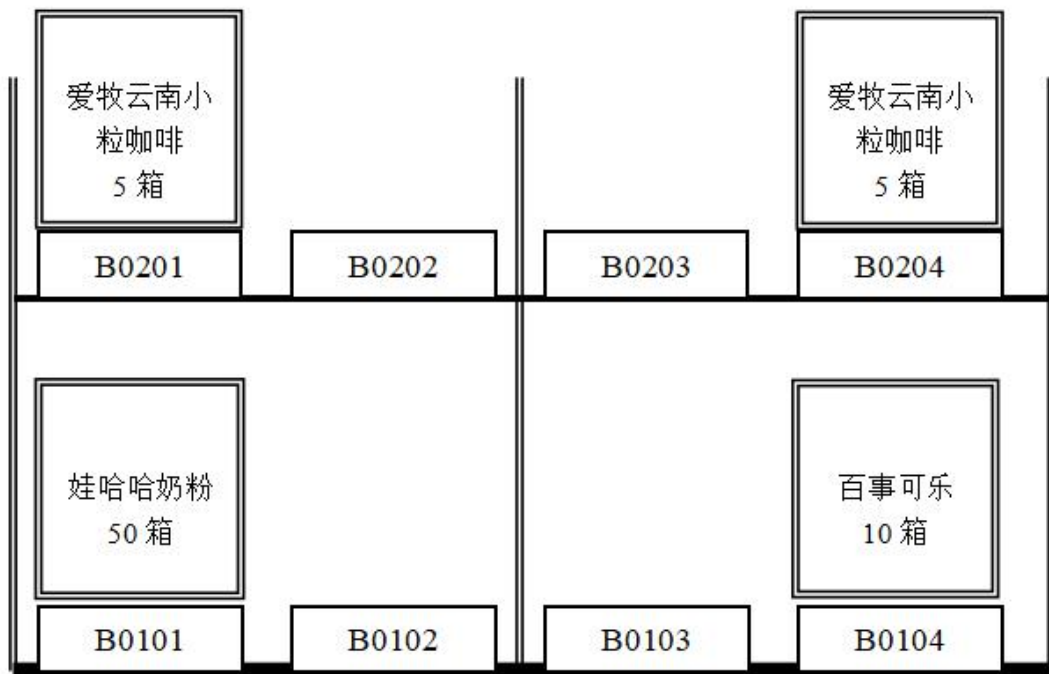
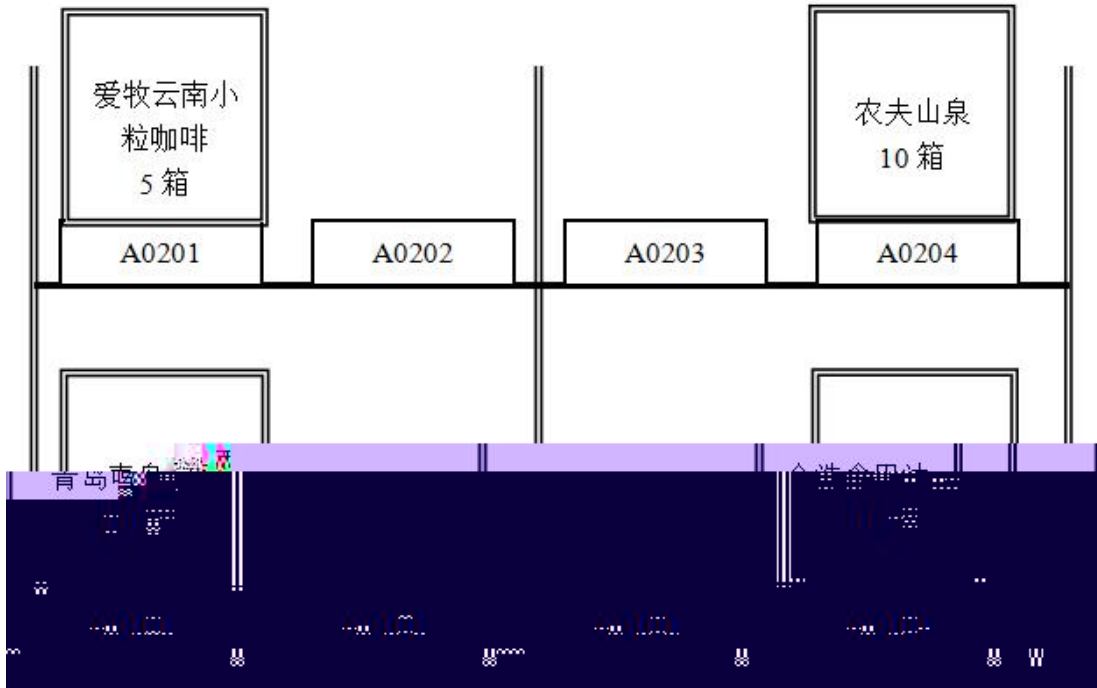

# 产品运输单

---



- 
- 
- 
- 
- 
- 
- 
- 
-











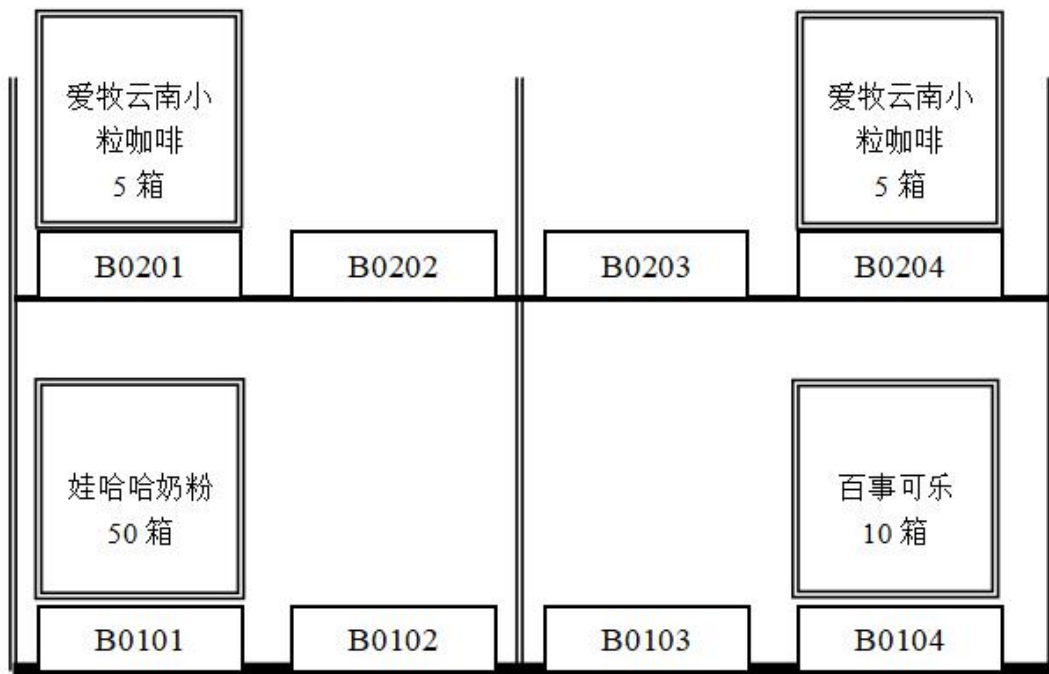
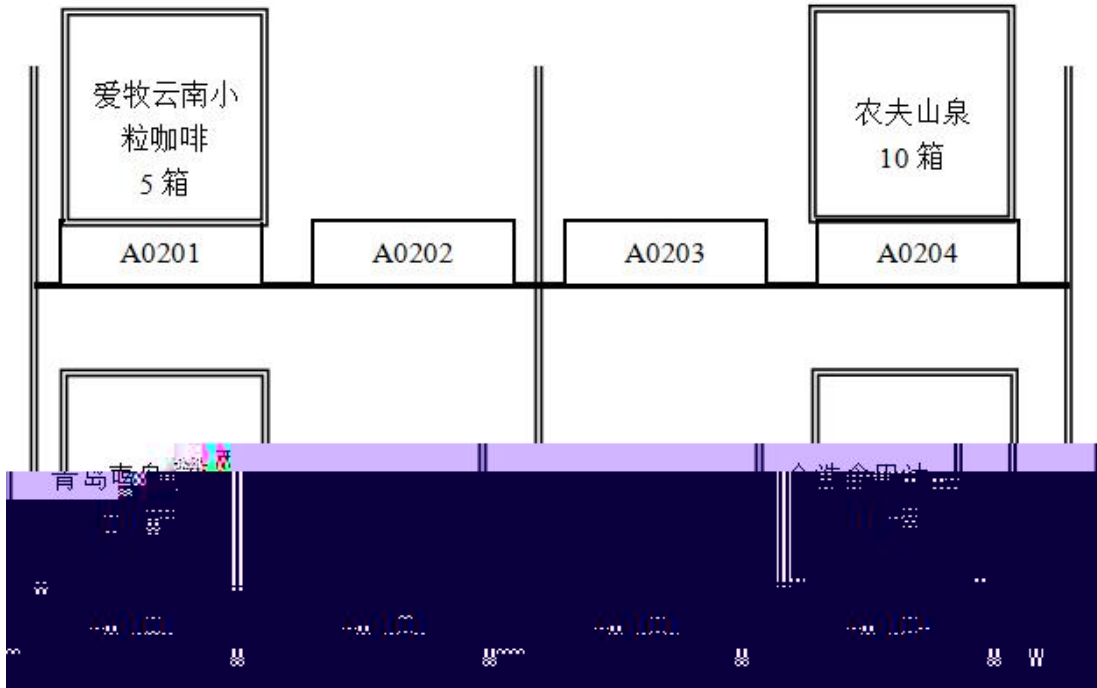

# 产品运输单

---



- 
- 
- 
- 
- 
- 
- 
- 







○

---



---



---

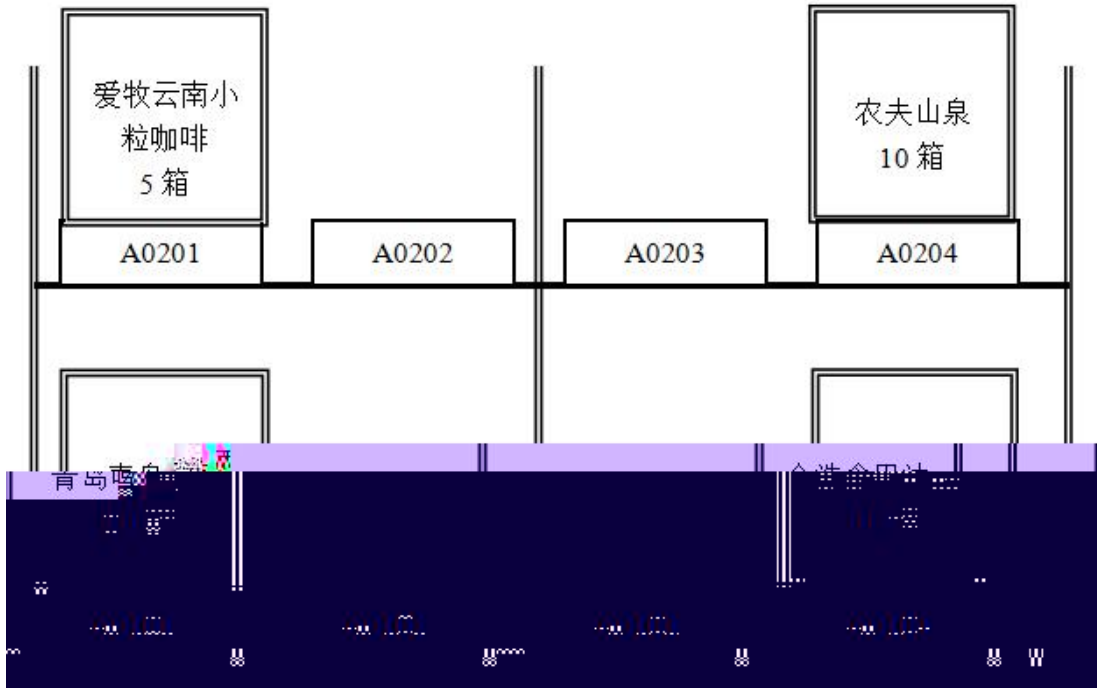



CW



---

--	--	--	--	--	--

---



---

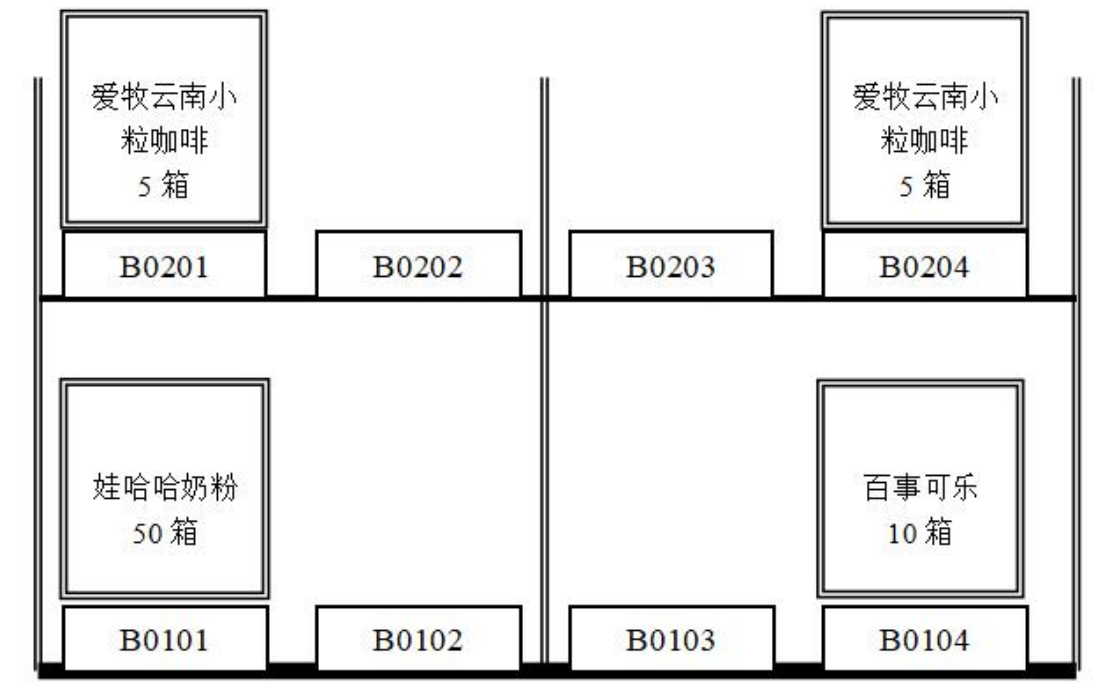
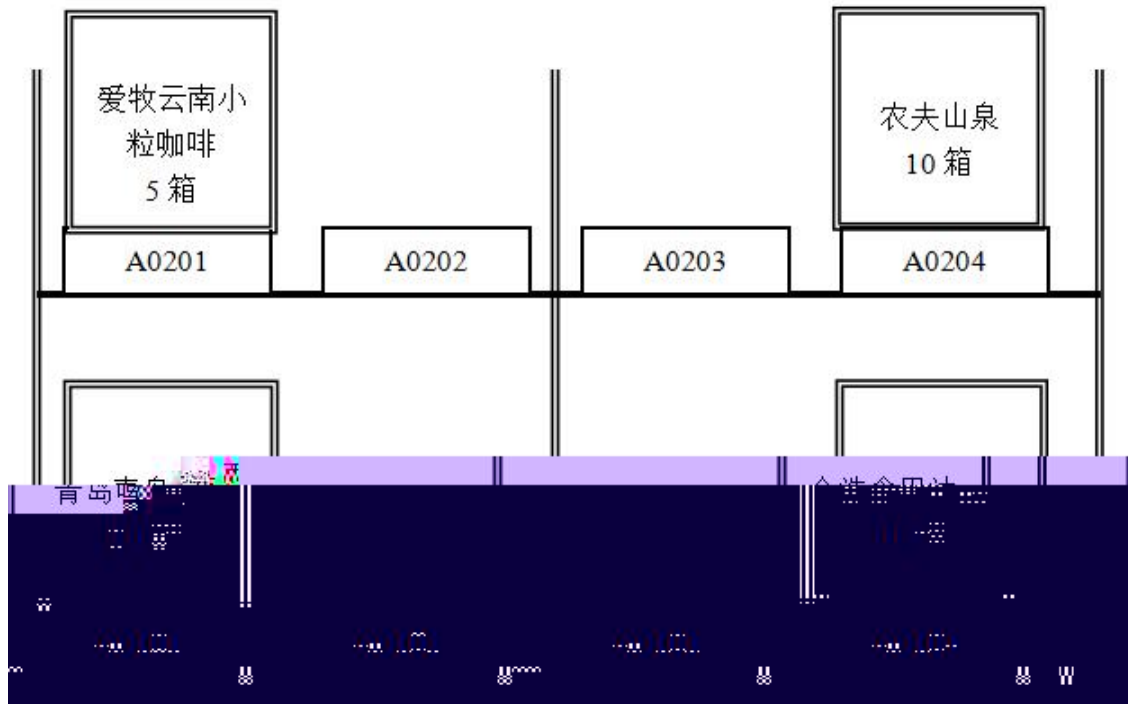

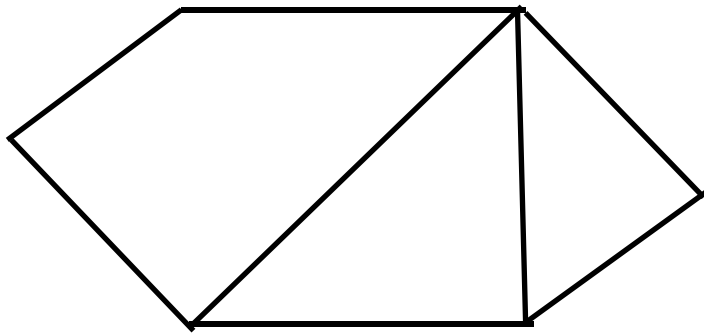







---

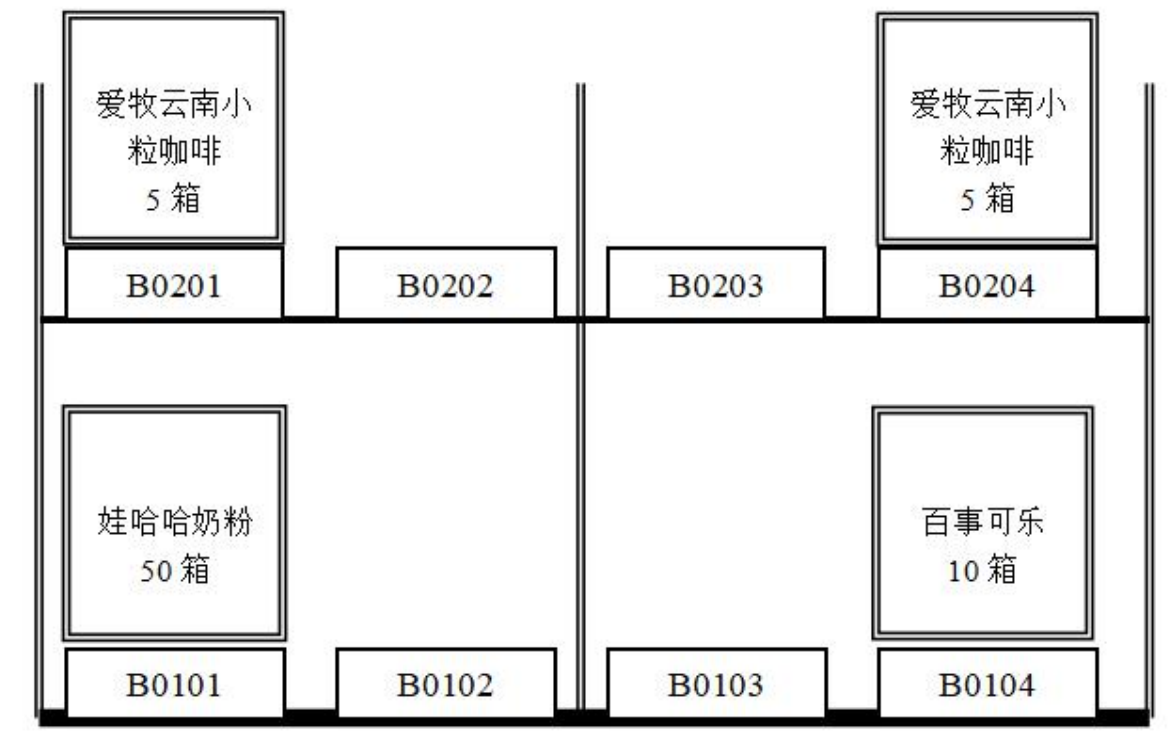
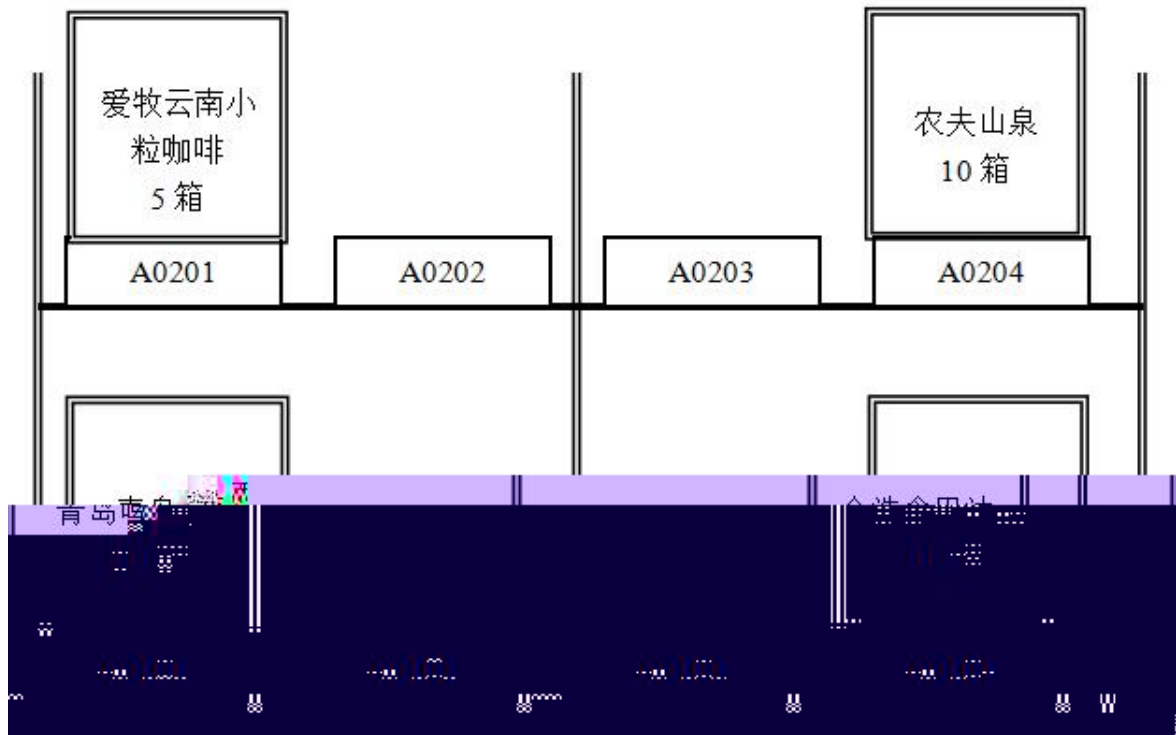

---









1

---



---



---

--	--



---



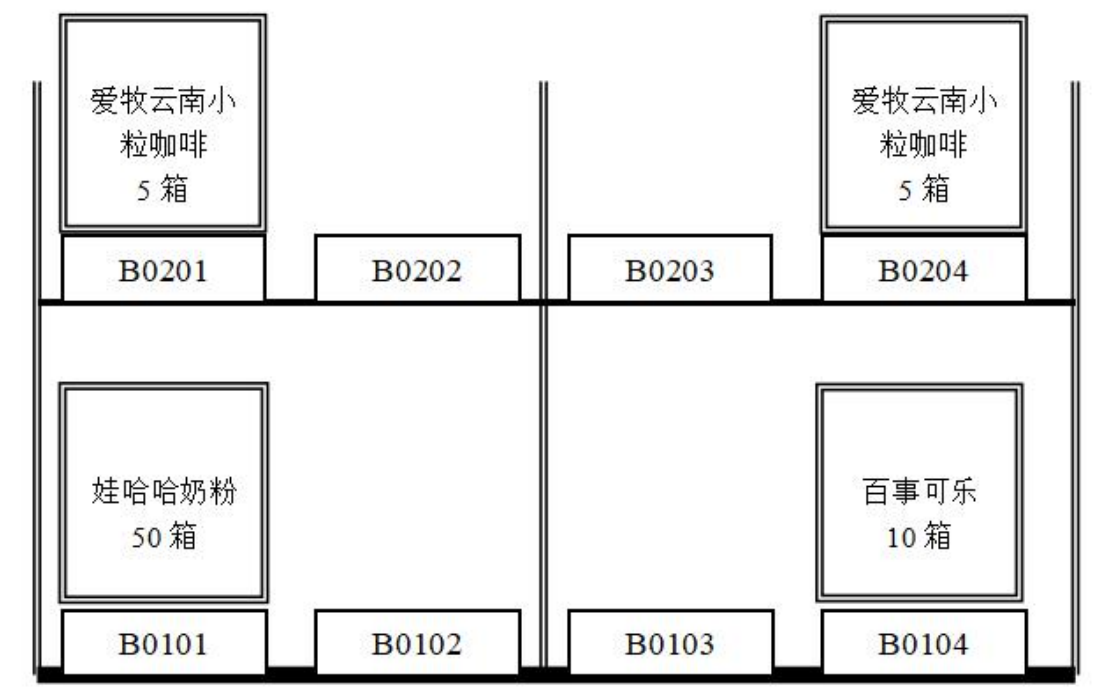
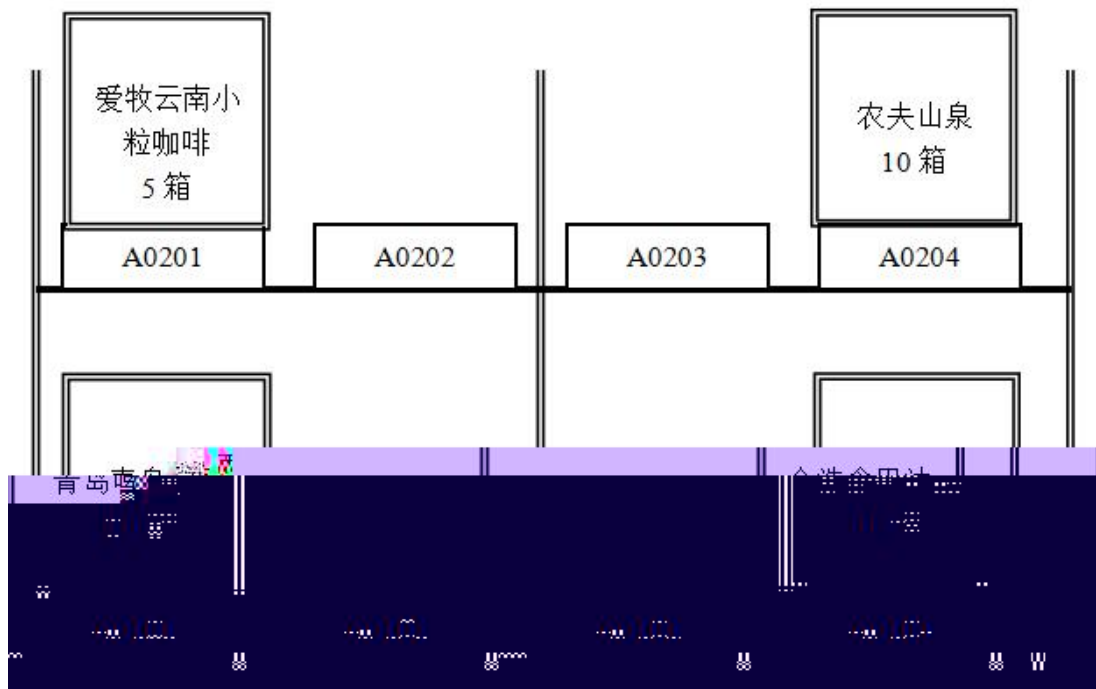





**1**

---



--	--	--	--	--	--

---

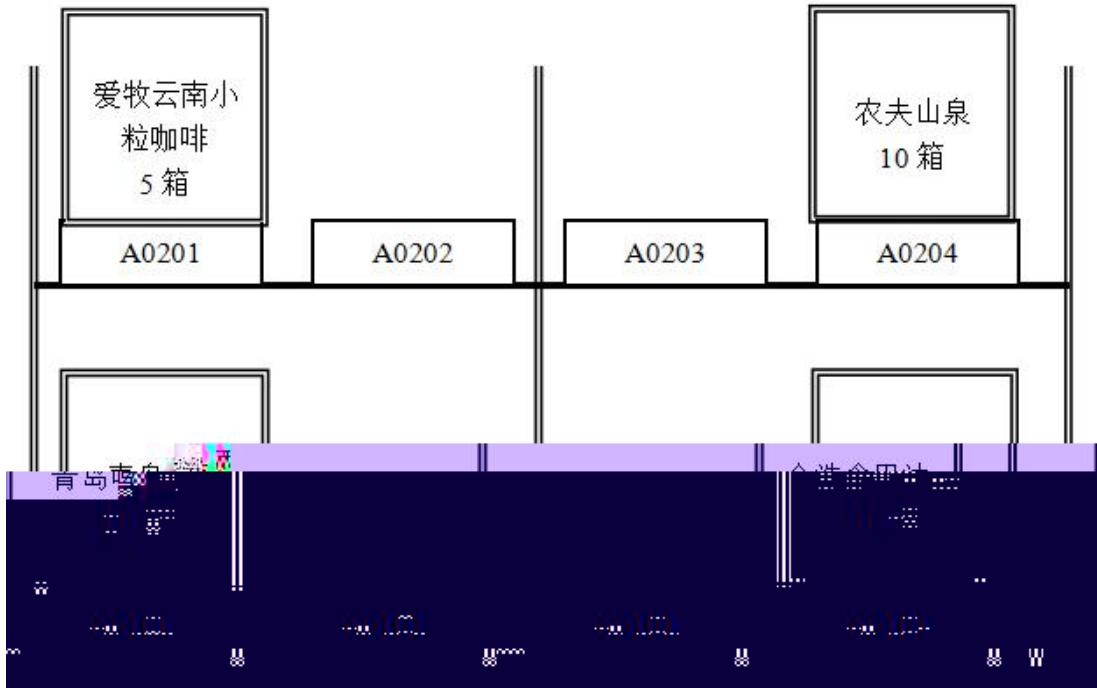

---

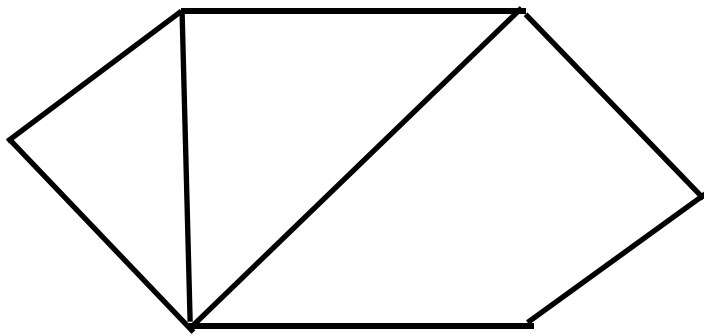











○

○













○

○











○

○













○

○

--	--











○

○







### 三、国际物流作业组织与管理模块



○



---

---

---

---





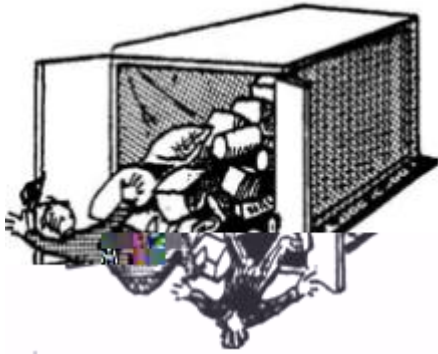
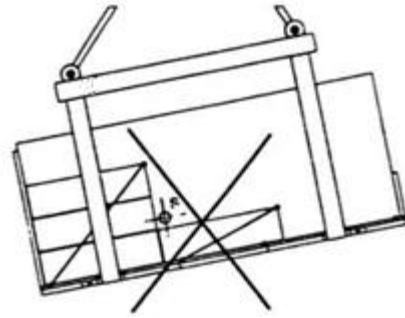





○

船公司	船名/航次	服务代码	航线	装船港/卸船港	启-达日期	天	挂港
Carrier	Voyage	Service	Lane	Load/Unload Port	ETD-ETA	Day	Port
MSC	MASTER		中国-香港	HONG KONG 香港	02/25 (二)	1	香港
地中海航运	74087		中国-香港	KAOHSIUNG 高雄	02/15	1	高雄
NYE	ITALIAN EXPRESS		中国-香港	HONG KONG 香港	02/25 (二)	1	香港
日本邮船	E 024		中国-香港	BANGKOK 曼谷	02/02 (三)	1	曼谷
CMA-CGM	CMA CGM GEMINI		中国-香港	XIAMEN 厦门	02/08 (二)	1	厦门
地中海航运	03A498		中国-香港	DUBAI 迪拜	02/07 (二)	1	迪拜
ALDIA	AVINDAI PLATINUM		中国-香港	SHANGHAI 上海	02/28 (二)	1	上海
日本邮船	M 0040		中国-香港	PANAMA 巴拿马	04/09 (三)	1	巴拿马
EMS	EMER KALESTIN		中国-香港	HONG KONG 香港	02/25 (二)	1	香港
日本邮船	E 0240		中国-香港	KOBE 神户	04/02 (三)	1	神户
PSL	PSL PERMAPAN		中国-香港	QINGDAO 青岛	02/26 (三)	1	青岛
日本邮船	VERMIA		中国-香港	MADRAS 马德拉斯	02/18 (二)	1	马德拉斯
ZON	HUI HONG	CHINA_NORTH	中国-香港	NINGBO 宁波	02/28 (二)	1	宁波
日本邮船	311	AM TW	中国-香港	HONG KONG 香港	02/15	1	香港
ARMANIER	HEBER R		中国-香港	KAOHSIUNG 高雄	02/25 (二)	1	高雄
日本邮船	2404		中国-香港	MONTELO	04/02 (三)	1	蒙特洛
DEAN	DEAN SAN NICOLA		中国-香港	SHANGHAI 上海	02/22 (二)	1	上海
日本邮船	E 00409		中国-香港	FOC GRANDE 福奥格兰德	04/07 (一)	1	福奥格兰德
OOCL	ORFIDEN EXPRESS	Pacific ATL	中国-香港	SHANGHAI 上海	02/28 (二)	1	上海
日本邮船	E 1808	ANTIC PAC	中国-香港	HALDIA 哈利迪	04/14 (一)	1	哈利迪



○  
○

<b>BEIJING</b>	<b>CN</b>		<b>BJ\$</b>
<b>Y. RENMINBI</b>	<b>CNY</b>		<b>KGS</b>
<b>BOSTON</b>	<b>US</b>	<b>M</b>	<b>630.00</b>
		<b>N</b>	<b>79.97</b>
		<b>45</b>	<b>60.16</b>
		<b>100</b>	<b>53.19</b>
		<b>300</b>	<b>45.80</b>



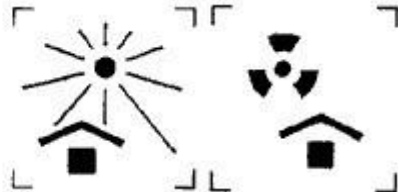

○





○

○







---

---

---

---

---

---

---

---

**集装箱设备交接单  
EQUIPMENT INTERCHANGE RECEIPT**

**OUT 出场**

No.

用箱人/运箱人(CNTR. USER/HAULIER)			提箱地点(PLACE OF DELIVERY)		
发往地点(DELIVERED TO)			返回/收箱地点(PLACE OF RETURN)		
船名/航次(VESSEL/VOYAGE No.)		集装箱号(CNTR. No.)		尺寸/类型(SIZE/TYPE)	
提单号(B/L No.)		危险品类别(IMCO CLASS)		箱封号(SEAL No.)	
免费期限(FREE TIME PERIOD)		承运工具牌号(TRUCK WAGON BARGE No.)		普通集装箱(GP. CNTR.)	
货重(CARGO W.)		出场目的/状态(PPS OF GATE-OUT/STATUS)		进场目的/状态(PPS OF GATE-IN/STATUS)	
				出场日期(TIME-OUT)	
				月 日 时	
出场检查记录(INSPECTION AT THE TIME OF INTERCHANGE)					
普通集装箱(GP. CNTR.)		冷藏集装箱(RP. CNTR.)		特种集装箱(SPL. CNTR.)	
发电机(GEN. SET)		正常(SOUND)		正常(SOUND)	
异常(DEFFECTIVE)		异常(DEFFECTIVE)		异常(DEFFECTIVE)	
损坏记录及代号(DAMAGE CODE)		记录温度(RECORDED)		记录温度(RECORDED)	













--	--	--	--	--	--

















--	--	--



--	--	--	--	--	--





--	--	--	--	--	--

--	--	--	--	--	--	--	--

○













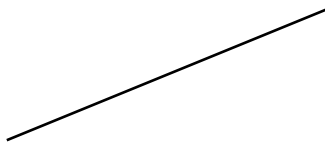

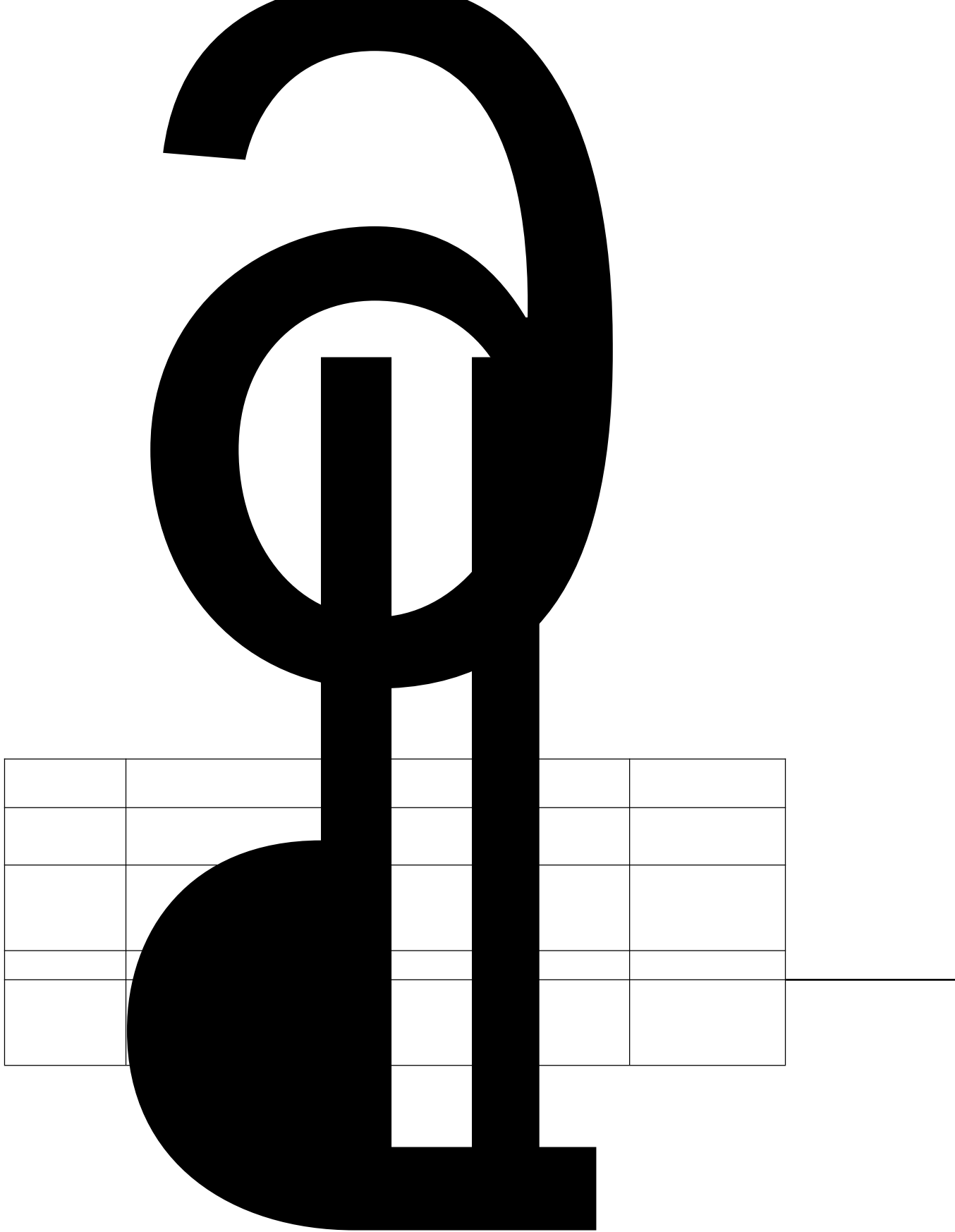







○

--	--	--











--	--	--	--	--	--

○

○

○



○







#### 四、 快递物流作业组织与管理模块























--	--	--	--	--	--

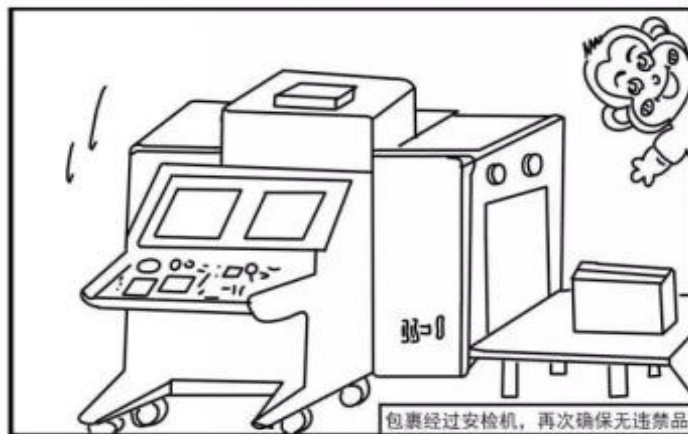
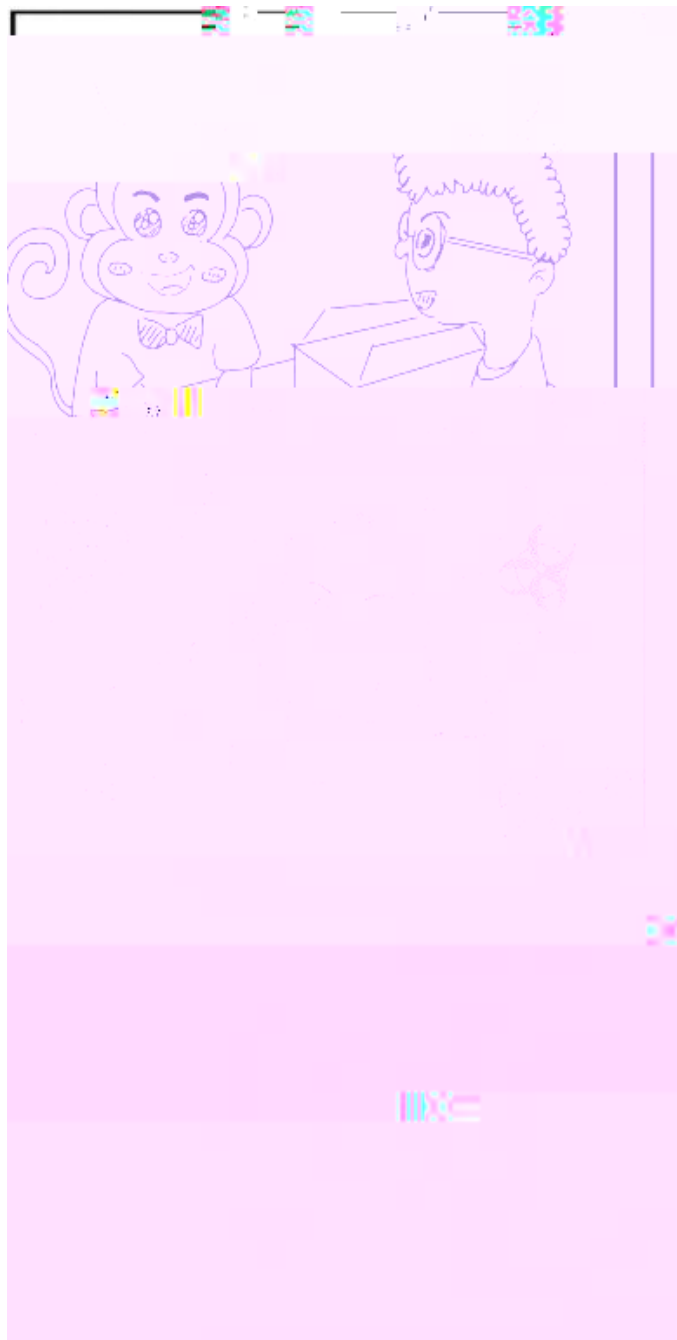



--	--	--	--	--	--

ep













---





--	--	--	--	--	--



[想知道:中国成都理工大学校园快递具体在哪? 百度知道](#)

3个回答 - 提问时间: 2014年02月10日

最佳答案  均在银杏后面。宝盒、圆通、顺丰在电影院后面。中通、申通在图书馆下面。常用的是这几个。

[zhidao.baidu.com/link?...](http://zhidao.baidu.com/link?...) 2014-02-15 - 百度快照 - 80%好评



















--	--	--	--



















--	--	--	--













\_\_\_\_\_



































































<hr/>
-------

